

A few simple steps to ensure  
perfect water, every time.



# Use and Care Guide

MODELS: A8CTBOTTLELESSWHT • A8CTBOTTLELESSBLK

## Registration

Please visit the website below to register your new water cooler within the first 30 days of purchase. Registration within the first 30 days will activate your one year warranty.

[www.avalonh2o.com/register-my-avalon-cooler](http://www.avalonh2o.com/register-my-avalon-cooler)

Please keep your model number, order number and purchase date for future support. You can reach us at 1-800-256-0695.

Model Number \_\_\_\_\_

Order Number \_\_\_\_\_

Purchase Date \_\_\_\_\_



This product conforms to NSF/ANSI 42 and 53 for the reduction of Chlorine taste and odor, nominal particulate class I, lead and cysts.

# Contents

## About Your Water Cooler

Meet Your Avalon Product	1-2
Part Names	3-4
Indicator Lights	5
Tech Specs	6
Filter Function Introduction	7

## Getting Started

Unpacking	9
Installation (Under the Sink)	10-11
Installation (Refrigerator Water Line)	12
Flushing Filters	13-14
Finishing Water Cooler Installation	14-18

## User Guide and Maintenance

Replacing the Filters	20-22
Leak Detection	23

## Cleaning

Activating Self-Cleaning Function	25
Rinsing, Cleaning, and Draining	26-27

## Troubleshooting

Safety	33-34
--------	-------

# Meet Your Avalon Product

Inside the box, you'll find:

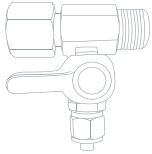

Adapter with Valve

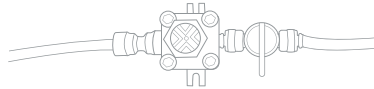

Valve and  
Tube Assembly

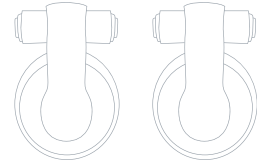

2 Filter  
Adapters



Carbon Block Filter



Sediment Filter



2 Small PE Tubing

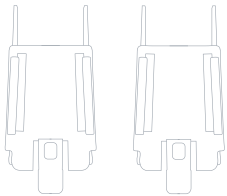

2 Mounting Brackets

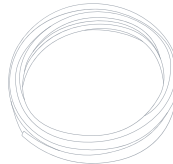

PE Tubing (20')

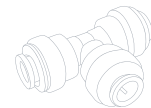

Three Way  
Plastic Adapter

## Meet Your Avalon Product



### Attractive Design

Modern countertop design with press-paddle spouts



### Custom Temperature

Piping hot or crisp cold water



### Dual Stage Filtration

Double the filtration for twice the peace of mind



### Worry-Free Cleaning

Self-cleaning ozone function for longer lasting water purification



### Built-in Nightlight

Makes late night water trips a breeze



### NSF Certified Filters

We meet strict standards for public health protection



### UL Listed

We design & manufacture with your safety in mind



### Energy Star Approved

Saves the environment & your wallet



### Child Safety Feature

Ensures safe hot water flow for the entire family

# Part Names

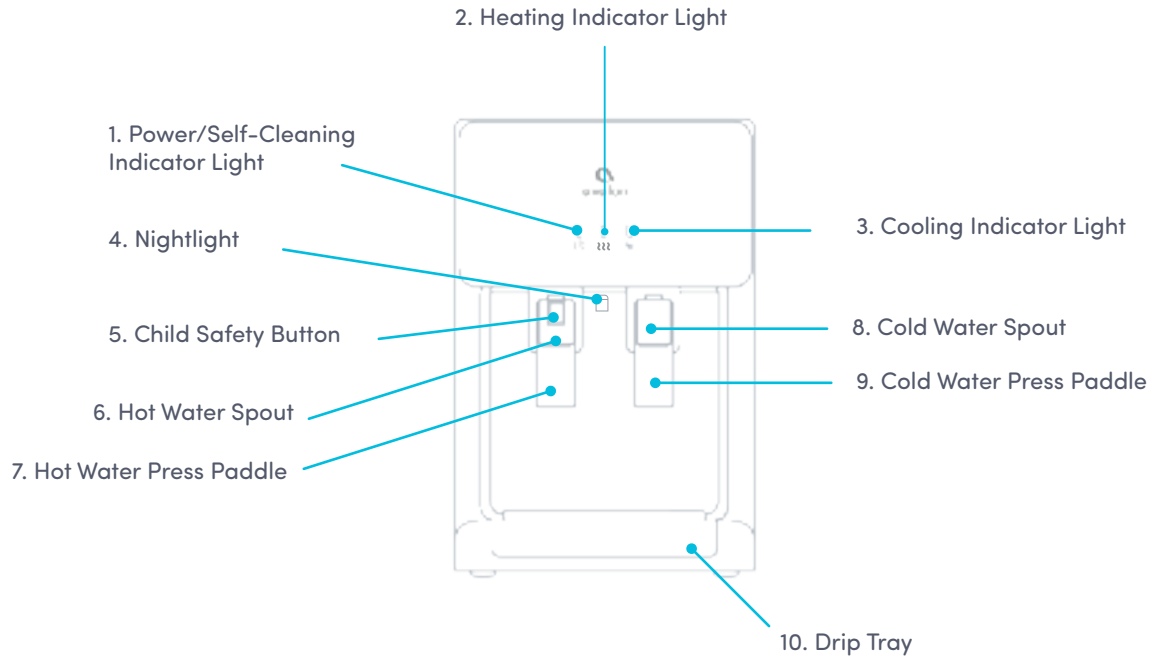

# Part Names

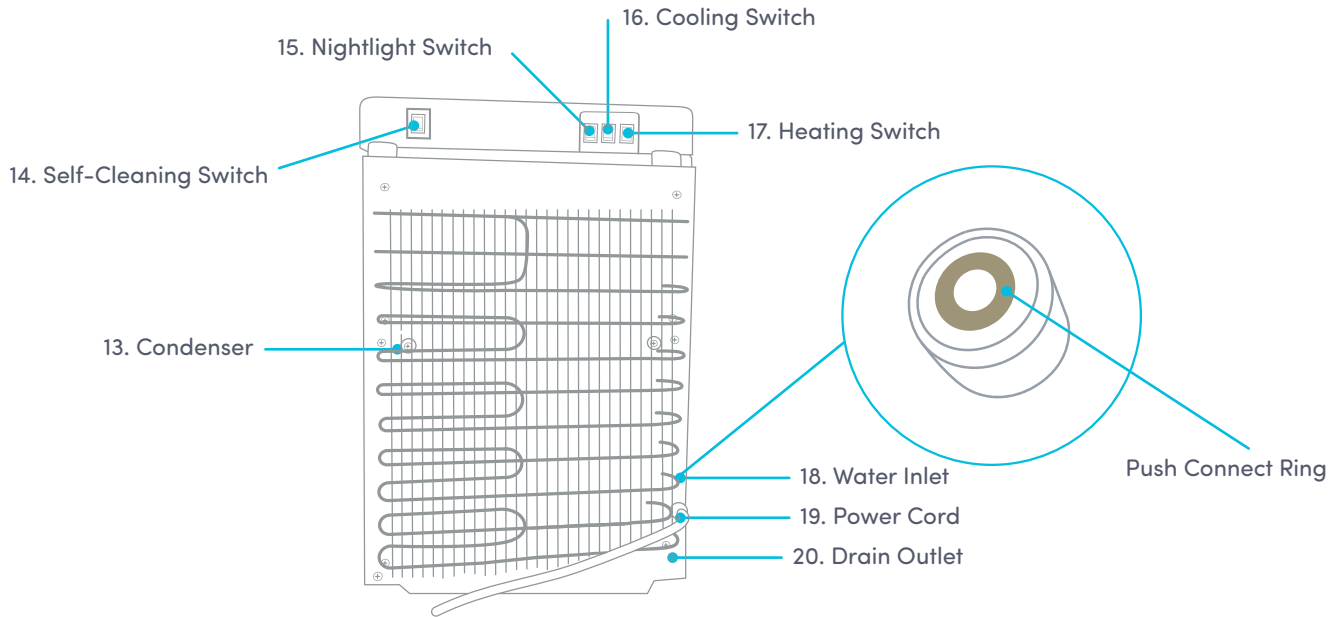
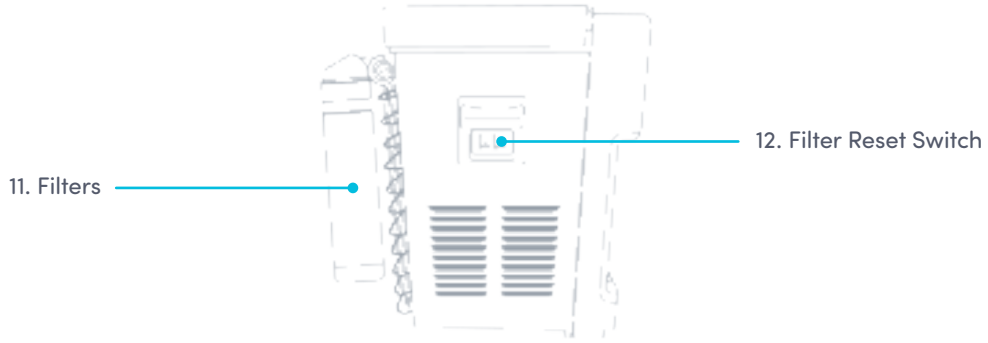

## Indicator Lights

### Power/Self-Cleaning Indicator Light



This light will remain steady on to indicate that the unit is plugged in and the power is on. When the unit is placed into self-cleaning mode this indicator light will blink until the cycle is complete. When the cycle is complete the light will return to steady on.

### Heating Indicator Light



This light will indicate when the water is heating. The light will remain on while the water is heating and will turn off when it has reached the correct temperature of 185°F. As the water is dispensed the hot tank will refill and the water will heat. As the water reheats this indicator light will turn on.

### Cooling Indicator Light



This light will indicate when the water is cooling. The light will remain on while the water is cooling and will turn off when it has reached the correct temperature of 47°F. As the water is dispensed the cold tank will refill and the water will cool. As the water cools this indicator light will turn on.

### Filter Indicator Light



The Heating Indicator Light and the Cooling Indicator Light will blink together to alert you that the filter needs to be replaced soon. They will continue to blink and a beep will sound to let you know to change the filter now.



## Tech Specs

Model	A8CTBOTTLELESSWHT • A8CTBOTTLELESSBLK
Hot/Cold Temp Output	1.2L/min / 1.2L/min
Hot Water Capacity	4 L/H ( ≥ 185°F)
Hot Tank Volume	1.16 Liters
Cold Water Capacity	2.5 L/H ( ≤ 47°F)
Cold Tank Volume	3.6 Liters
Applicable Water Pressure	0.1-0.4 MPa
Applicable Water	Tap Water
Stage 1 Filtration	Sediment Filter
Stage 2 Filtration	Carbon Block Filter
Product Size	13"(L)x12"(W)x19"(H)
Packing Size	16.18"(L)x15.07"(W)x28.34"(H)
Net Weight/Gross Weight	35.27 lb / 39.70 lb
Voltage/Frequency	115 V 60Hz
Cooling Method	Compressor
Heating Method	Internal Element
Heating Watts / Cooling Watts	420W / 100 W
Power Consumption	520 W

## Filter Function Introduction

Stage	Filter	Function
Stage 1	Sediment Filter	Course filtration of raw water to remove rust, dirt and sediment
Stage 2	Carbon Block Filter	Removes the water odor, residual chlorine, organic matter, and lead to improve taste

Getting Started

# Unpacking Your Avalon Water Cooler

## Locating Dispenser

- Do NOT plug in the power cord yet.
- Place dispenser upright on a hard and level surface in a cool and shaded location near a grounded wall outlet. Position the dispenser so there is about 4 inches of clearance from the wall on the back and both sides.

## Locating Accessories

- Open the top of the packaging and remove the top foam piece along with accessories and place them aside. (The filter will be located in this foam piece located on the top of the cooler.)
- Unpack the product and install the drip tray by inserting it into place.

## Installation (Under the Sink)

### Installing the Metal Adapter with Valve

1. Turn off the current cold water supply that is the source of water to your sink.

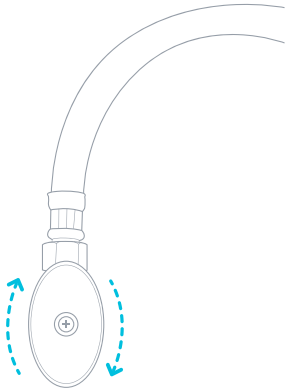

2. Disconnect the current cold water supply line under your sink.

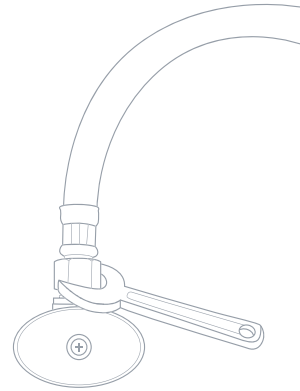

3. Connect the Metal Adapter with valve between the cold water supply line and cold water valve.

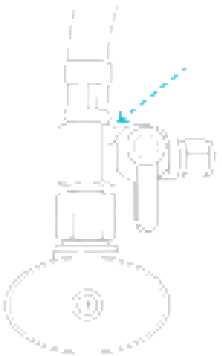

## Installation (Under the Sink)

### Installing the Metal Adapter with Valve

4. Remove the nut from the Metal Adapter and insert the PE Tubing through the nut. Slide the PE Tubing onto the protruding part of the Metal Adapter where the nut was located until it reaches the threading.

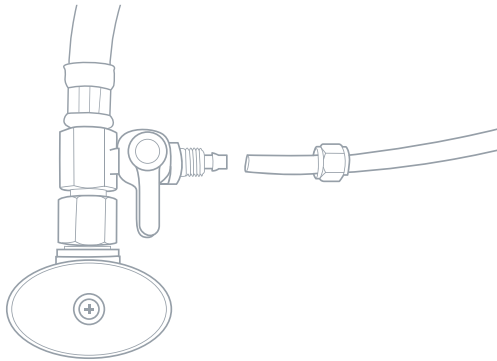

5. Screw the nut tightly into place to keep the PE Tubing securely connected to the Metal Adapter with Valve. Make sure the valve is in the off position (perpendicular to the PE Tubing).

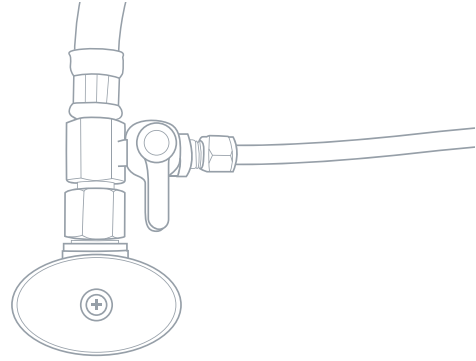

## Installation (Refrigerator Water Line)

### Installing the Three Way Plastic Adapter

1. Turn off the current cold water supply that is the source of water to your refrigerator line.

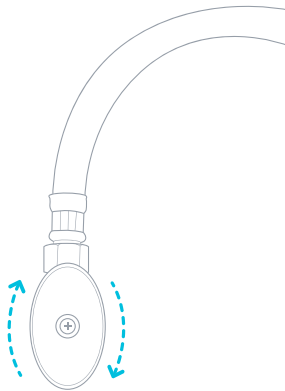

2. Cut the current 1/4" tubing that is connected to the back of your refrigerator or ice maker near the end of it that is currently inserted into the refrigerator.

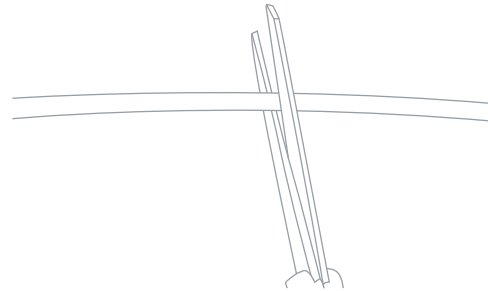

3. Insert each cut end of the existing 1/4" tubing into one of the holes of the Three Way Plastic Adapter.

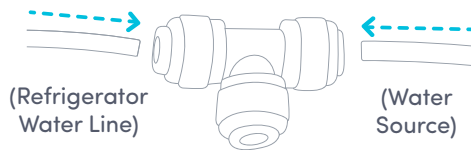

4. Insert one end of the PE Tubing that is supplied with the water cooler into the third opening of the Three Way Plastic Adapter.

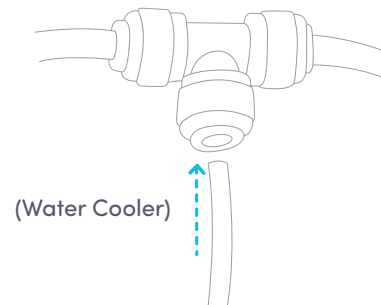

## Flushing Filters Prior to Use

Before continuing with installation, it is recommended that you flush both filters for approximately 2 minutes.

1. Twist the filter into the provided Filter Flushing Adapter by rotating it clockwise.

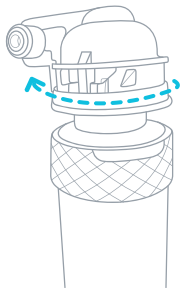

2. Take the open end of the PE Tubing that is now connected to your water supply and insert it into the left inlet hole on the Filter Flushing Adapter in the direction of the arrow.

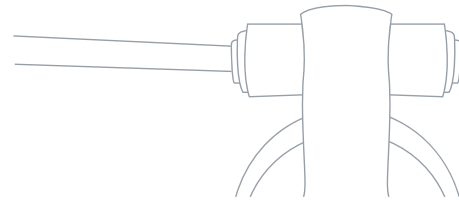

3. Hold the filter with the Filter Flushing Adapter in place over a sink. Turn the Valve of the Metal Adapter at the water source to the on position (the on position is parallel to the PE Tubing) and allow the water to flow through the Adapter and the filter for approximately 2 minutes to flush the new filter.

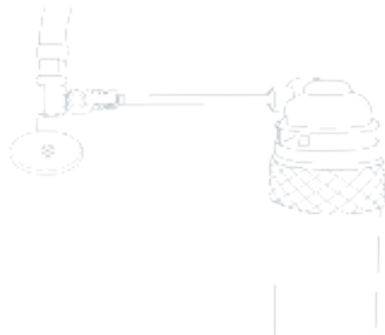



## Flushing Filters Prior to Use

4. Turn the Valve of the Metal Adapter at the water source back to the off position, remove the filter from the Filter Flushing Adapter.

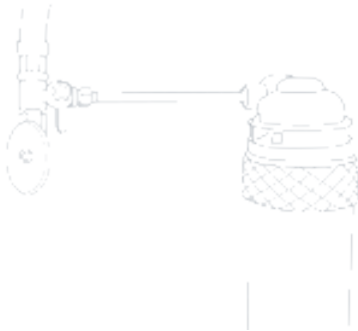

5. Remove the end of the PE Tubing from the Filter Flushing Adapter by pressing in on the push connect ring and pulling out the PE Tubing.

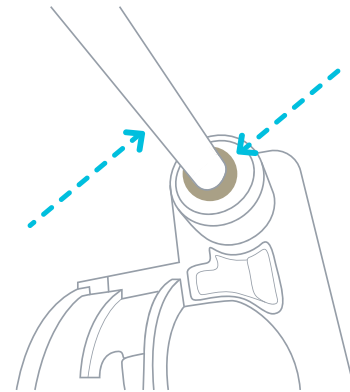

Repeat steps 1-5 for flushing the Carbon Block Filter.

## Finishing the Water Cooler Installation

Once you have flushed the filters and removed the filters and PE Tubing from the Filter Flushing Adaptor, you are ready to complete the installation process.

1. Locate the two black Mounting Brackets. Clip each bracket, one next to the other, onto the top of the back of the cooler by inserting the longer pegs upward into the slots of the condenser then click the shorter pegs into place.

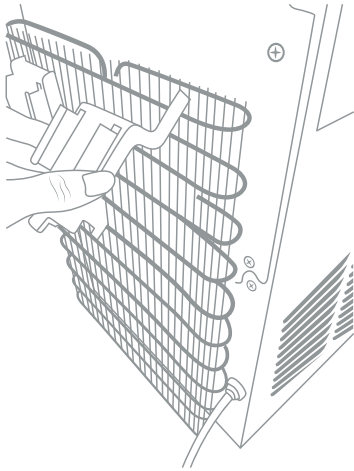

2. Slide the 2 Filter Adapters into each of the Mounting Brackets. Twist the Sediment Filter into the left Filter Adapter and the Carbon Block Filter into the right Filter Adapter. Rotate the filters clockwise to twist them into place.

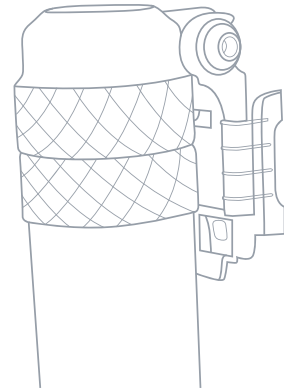

## Finishing the Water Cooler Installation

3. Locate the Valve and Tube Assembly. Connect the tube end of this assembly to the left insert on the left Filter Adapter.

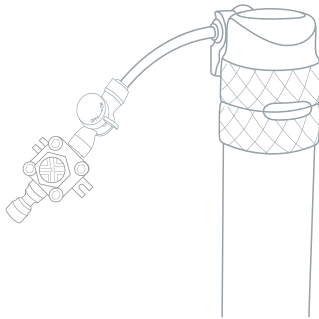

4. Connect the PE Tubing (20'), that is connected to the water source, to the open end of the Valve and Tube Assembly. Make sure that the valve is in the off position (perpendicular to the PE Tubing).

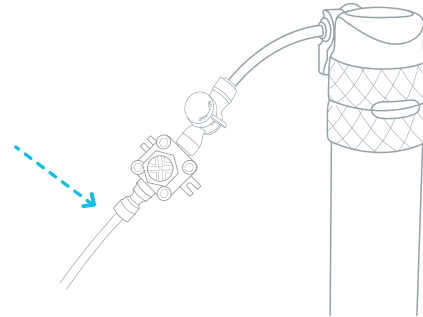

5. Using the Small PE Tubing, connect the right side inlet of the first Filter Adapter to the left side inlet of the second Filter Adapter.

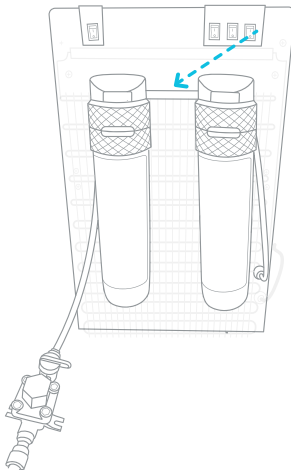

## Finishing the Water Cooler Installation

6. Remove the plug from the water inlet (#18) located on the back of the unit. To do this press on the push connect ring in towards the cooler and remove the plug at the same time.

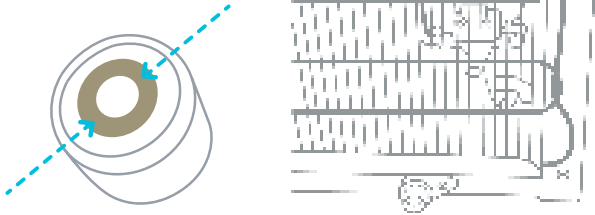

7. Locate the second Small PE Tubing. Connect one end of the Small PE Tubing to the right side inlet of the right Filter Adapter. Connect the other end of that Small PE Tubing to the water inlet (#18).

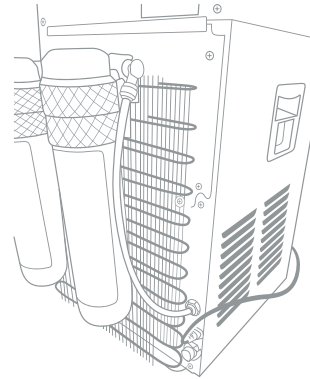

8. Locate the valve on the Valve and Tube Assembly. Turn this valve to the on position (parallel to the PE Tubing) to allow water to flow through.



## Finishing the Water Cooler Installation

9. Locate the Adapter with Valve that is connected to the water source. Turn this valve to the on position (parallel to the PE Tubing) to allow the water to flow through.

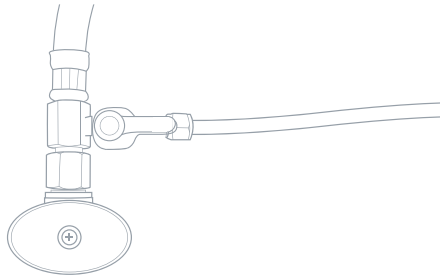

11. Be sure to dispense a little water from both the cold and hot water spouts (#8, #6) prior to turning on the cooling and heating switches (#16, #17) located on the back of the cooler.

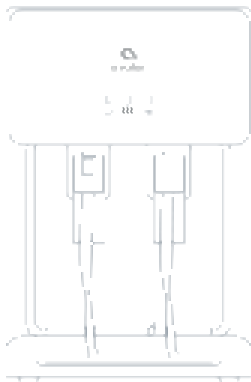

10. After the installation of the water line and filters is complete, plug the power cord into a grounded wall outlet and begin to use the machine. Please allow the machine about 10-15 minutes for the water to fill in the tanks before use.

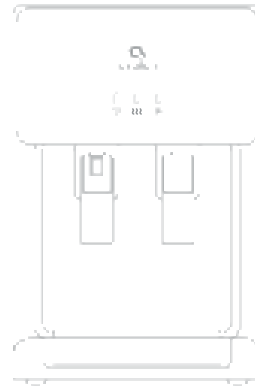

15-20  
min  
Hot

# User Guide and Maintenance

## Replacing the Filters

1. When lifetime of the filter is near its end, either by means of water flow or after 6 months time, the heating (#2) and cooling (#3) indicator lights will blink as a warning. When the filter lifetime is up, the heating (#2) and cooling (#3) indicator lights will continue to blink and the machine will beep to let you know that the filter needs to be changed.

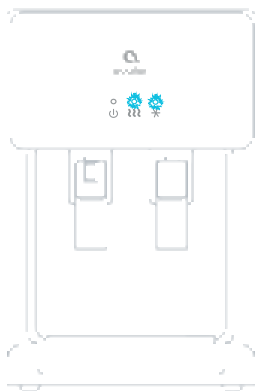

2. Shut off the valve located at the connection to the water source or the valve located to the left of the Sediment Filter on the back of the unit.

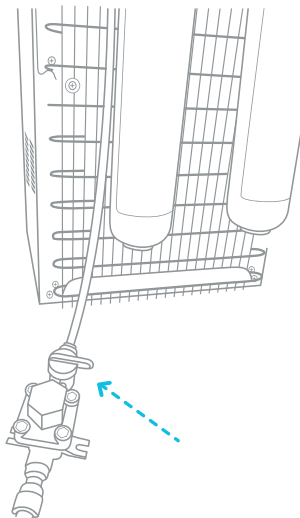

## Replacing the Filters

3. Twist the expired filters to remove them from the Filter Adapters at the back on the unit. Insert the new filters into the Filter Adapters by twisting them into place and rotating them clockwise. Make sure the Sediment Filter is on the left and Carbon Block Filter is on the right.

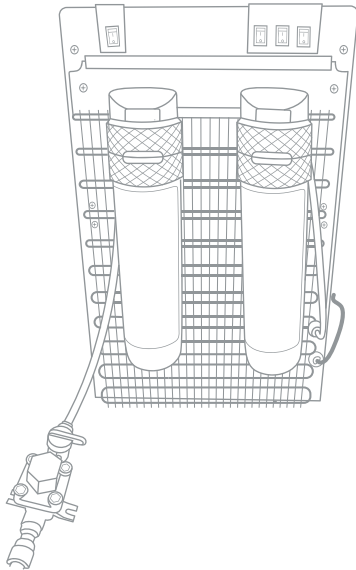

4. Turn on the Valve that was previously shut off. This valve will be located at the connection to the water source or located to the left of the Sediment Filter on the back of the unit.

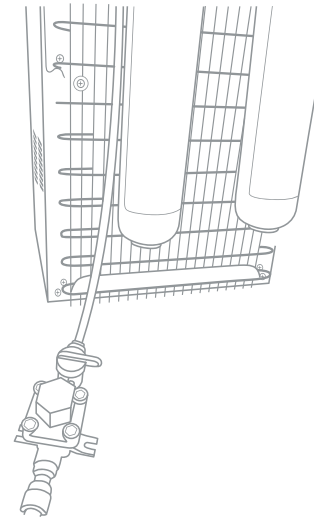



## Replacing the Filters

5. After replacing the filters, press and hold the filter reset button (#12) located on the left side of the unit. Press and hold this button until the heating (#2) and cooling (#3) indicator lights stop blinking.

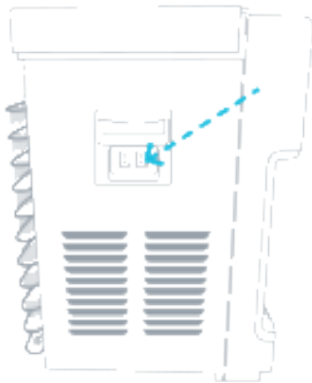

6. In order to flush the new filters, allow the water to flow from the cold water spout for approximately 2 minutes.

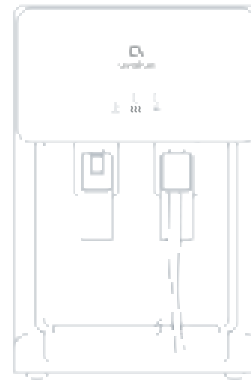

## Leak Detection

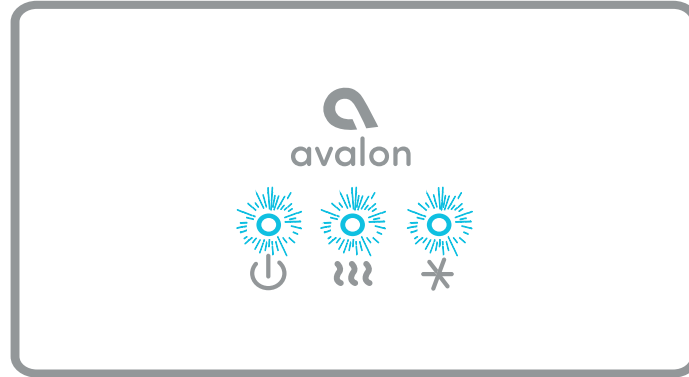

Our machines are equipped with a high-tech leak detector that will alert you of any potential leak. At the same time the machine will automatically shut off any intake of water to prevent a potential flood. In the event of a possible leak, power/self-cleaning indicator light (#1), the heating indicator light (#2) and cooling indicator light (#3) will start blinking and a beep will sound. Please check around the machine for any leaking water and determine the source of it. If you find the source of the leak, you can call our support line for assistance in fixing it. If you do not find the source of this leak, it may have been caused by accidental spillage of water or from a filter change. The leak detector is inside the machine and will need to be left to dry by itself once any excess water is removed.

Cleaning

## Activating Self-Cleaning Function

It is recommended that the self-cleaning feature is used once a week to sanitize the tanks and water lines.

1. To activate, press the self-cleaning switch (#14) and hold in the on (I) position for 5 seconds and release. The switch will immediately go back into the off (O) position.
2. The power/self-cleaning indicator light (#1) will begin to blink. This indicates the self-cleaning cycle is underway.
3. Ozone will be produced and injected into the water system, it will kill bacteria and bio-films typically found in water dispensers. By the end of the cleaning cycle the ozone will convert into harmless oxygen and will be emitted into the air.
4. When the self-cleaning cycle is complete the power/self-cleaning indicator light (#1) will stop blinking and will be steady.

**Please Note:** This self-cleaning cycle will take 90 minutes to complete. During this time do not dispense and drink the water. We recommend you do this during a period of time when the unit will not be in use for example overnight. During the cycle you may smell some of the ozone, this is normal.

## Rinsing, Cleaning, and Draining

To prolong the lifetime of the machine, it is recommended that the unit be cleaned and sanitized manually about every six months.

### To clean the outside of the unit

Use a disinfectant of your choice to wipe down the outside of the machine. Disinfectant does not come with this unit. It can be purchased separately from a local store.

### To rinse the inside of the unit

The machine has been disinfected prior to departing from the factory. However, it is recommended to rinse and drain the unit prior to installation.

1. Before cleaning, make sure that the cooling switch (#16) and heating switch (#17) are in the off (O) position and unplug the machine.



2. Remove the two screws located on the back (at the top, in line with the switches) of the cooler. Remove the top cover by lifting at an angle and pull off. Remove the white cold water tank cover and the separator.

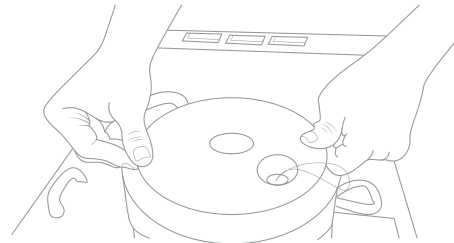
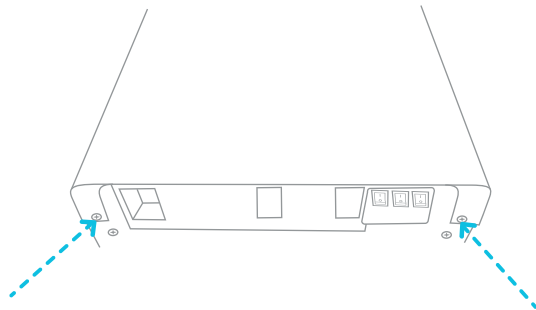

## Rinsing, Cleaning, and Draining

3. Pour 0.6 gallons of clean water into the cold tank. (The cold water tank is the open cylinder that the white cover was removed from).

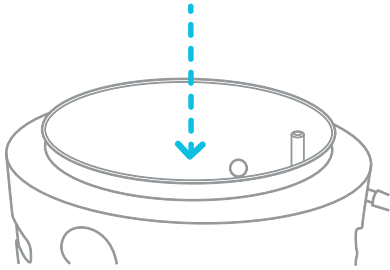

4. Place a large bucket beneath the drain outlet (#20) located on the back of the unit. Remove the drain cover and allow the water to drain from the unit. Water will start flowing as soon as the drain cover is removed.

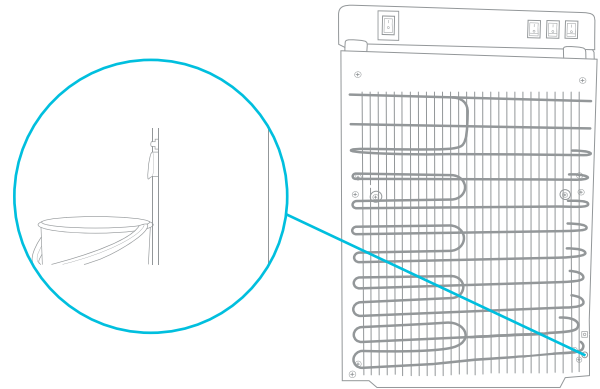

**Caution:** The dispenser will heat water to a temperature of approximately 185°F. It can cause severe burns if not handled carefully. Please use caution while operating and cleaning. Please allow ample time for any hot water inside the machine to cool down before draining it.

## Rinsing, Cleaning, and Draining

5. Once water is completely drained, reposition the drain cover, cold tank cover and the top cover. Ensure that the pipes and wires are connected properly and you may use the dispenser as normal.

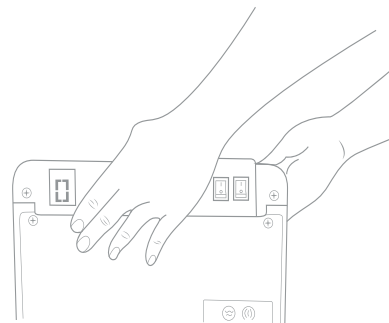
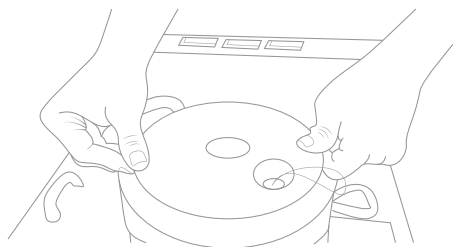
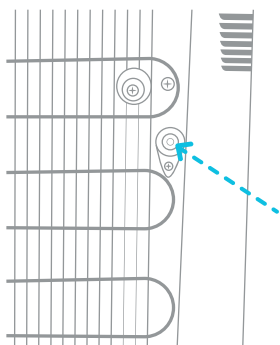

Troubleshooting



## Troubleshooting

If you are having trouble with your water cooler please see the following solutions. You can also view our trouble shooting videos at the website below. Please feel free to contact us with any questions.



1-800-256-0695



[support@avalonh2o.com](mailto:support@avalonh2o.com)



[www.avalonh2o.com](http://www.avalonh2o.com)

## Troubleshooting

### Indicator lights are flashing and unit is beeping

If indicator lights #1, #2, #3 are flashing and the unit is making a slow beeping sound, it is alerting you that there may be a leak in the unit. Please refer to page 23.

Please turn off the switches on the back of the unit and unplug the unit.

Ensure that the bottom of the cabinet is completely dry. The sensor is located in the back left corner. Make sure there is no water on the sensor.

Once the unit is dry you may plug it back in and turn the switches to the on position and continue normal use.

### Water leaking from unit

- Check to make sure that pipes are connected properly.
- Inspect the adapter to ensure that it is connected properly.
- Water pipe may need to be replaced.

### Water not dispensing at a hot or cold temperature

This could be caused by an over consumption of water in a short period of time causing the tanks to empty. Please allow 5 to 10 minutes for the water cooler tanks to refill. Allow the proper time for the water to heat and cool.

This could be caused by an interruption in the power supply. Please ensure that the power cord is connected to an outlet. Please make sure that the heating (#17) and cooling (#16) switches are in the on (I) position.

Safety

## Safety

To reduce risk of injury and property damage, user must read this entire guide before assembling, installing and operating the dispenser.

Failure to execute the instructions in this manual can cause personal injury or property damage.

This product dispenses water at very high temperatures. Failure to use this properly can cause personal injury.

When operating this dispenser, always exercise basic safety precautions, including the following:

- Prior to use, this dispenser must be properly assembled and installed in accordance with this manual.
- This dispenser is intended for water dispensing only. Do NOT use other liquids. Do NOT use for other purposes. Never use any other liquid in the dispenser other than known microbiologically safe tap water.
- For indoor use only. Keep water dispenser in a dry place away from direct sunlight. Do NOT use outdoors.
- Install and use only on a hard, flat and level surface.
- Do NOT place dispenser in an enclosed space or cabinet.
- Do NOT operate the dispenser in the presence of explosive fumes.
- Position back of dispenser no closer than 20 cm from wall and permit free airflow between wall and dispenser. There must be at least 20 cm clearance on the sides of the dispenser to permit airflow.
- Use only properly grounded outlets.
- Do not use an extension cord with your water dispenser.
- Always grasp plug and pull straight out from outlet. Never unplug by pulling on power cord.
- To protect against electric shock, do NOT immerse cord, plug or any other part of the dispenser in water or other liquid.

## Safety

- Ensure dispenser is unplugged prior to cleaning.
- Never allow children to dispense hot water without proper and direct supervision. Unplug unit to prevent unsupervised use by children.
- Service should be performed only by a certified technician.
- Warning: Do not damage the refrigerant circuit.
- This appliance can be used by children aged from 8 years and above if they have been given supervision or instruction concerning use of the appliance in a safe way and if they understand the hazards involved. Cleaning and user maintenance shall not be made by children unless they are older than 8 and supervised. Keep the appliance and its cord out of reach of children less than 8 years.
- Appliances can be used by persons with reduced physical, sensory or mental capabilities or lack of experience and knowledge if they have been given supervision or instruction concerning use of the appliance in a safe way and understand the hazards involved. Children shall not play with the appliance.
- This appliance is intended to be used in a household and similar applications such as: kitchen area in shops, offices and other working environments, bed and breakfast type environments, catering and similar non-retail applications.
- Do not store explosive substances such as aerosol cans with flammable propellant in this appliance.
- If the supply cord is damaged, it must be replaced by a special cord assembly available from the manufacturer or its service agent.
- Never turn the machine upside down or lean it more than 45°.
- Thermostat has been adjusted. There is no need to adjust it by yourself. When the matching is below the freezing point and blocked by ice, the cooling switch should be turned off for 4 hours before turning it on again to continue its operation.
- This machine should not be plugged back in until 3 minutes after it has been unplugged.